

8193



7506024151016

SOPORTE PARA TRANSMISIÓN STD.

MARCA	MODELO		
MINI	COOPER	L4 1.6	07-17

OEM 22 31 6 784 355, 22 31 4 054 477
 22 31 4 055 001
 *Parque Vehicular: 53,889

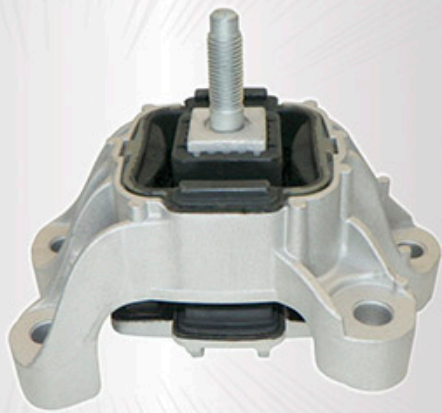

8209-H



7506024151177

SOPORTE PARA MOTOR IZQUIERDO

MARCA	MODELO		
BMW	520i	L4 2.0	18-19
BMW	540i	L6 3.0	17-20
BMW	530i	L4 2.0	17-22
BMW	X3	L4 2.0	18-20
BMW	X4	L4 2.0	19-22

OEM 22 11 6 860 495
 *Parque Vehicular: 23,781

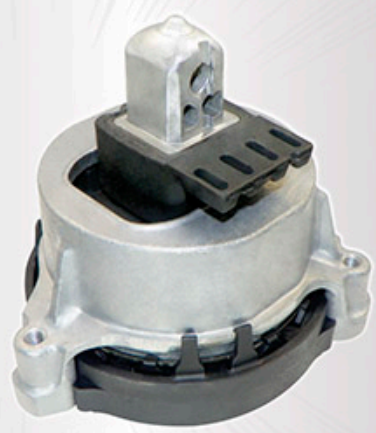

8308



7506024152204

SOPORTE PARA TRANSMISIÓN

MARCA	MODELO		
VOLKSWAGEN	UP	L3 1.0	16-18

OEM 150-199-555-A
 *Parque Vehicular: 9,357

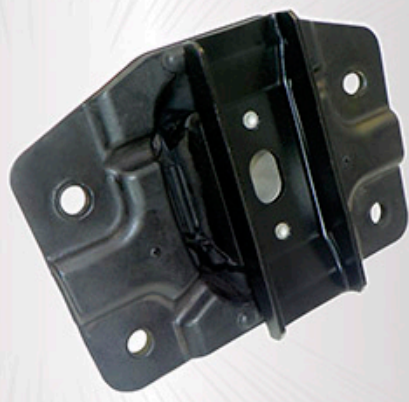



7506024162227

BASE PARA AMORTIGUADOR TRASERA IZQUIERDA Y DERECHA (HERRAJE)

MARCA	MODELO		
MITSUBISHI	ECLIPSE	L4 1.5	18-20
MITSUBISHI	LANCER	L4 2.0	02-17
MITSUBISHI	LANCER	L4 2.4	04-17
MITSUBISHI	OUTLANDER	L4 2.0	11-21
MITSUBISHI	OUTLANDER	L4 2.4	03-21
MITSUBISHI	OUTLANDER	V6 3.0	07-20

OEM MR491946

*Parque Vehicular: 145,125



8288



7506024154352

SOPORTE PARA MOTOR DERECHO TRANSMISIÓN AUTOMÁTICA

MARCA	MODELO		
MAZDA	2	L4 1.5	11-16

OEM DG8-39-060

*Parque Vehicular: 402,619



8368-H



7506024153720

SOPORTE PARA MOTOR DERECHO

MARCA	MODELO		
CHRYSLER	200	L4 2.4	13-14
DODGE	AVENGER	L4 2.4	12-14
DODGE	JOURNEY	L4 2.4	11-20

OEM 5147130AE

*Parque Vehicular: 154,164

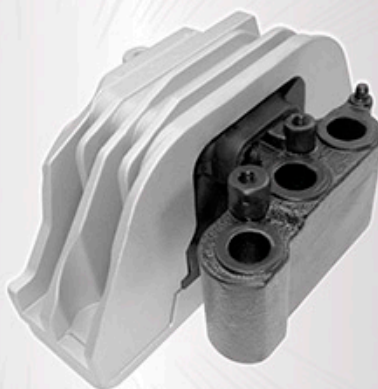

8375





7506024153829

SOPORTE PARA MOTOR DERECHO

MARCA	MODELO		
AUDI	A3	L4 2.0 DIESEL	10-13
VOLKSWAGEN	BEETLE	L4 2.0 DIESEL	11-16
VOLKSWAGEN	CADDY	L4 2.0 DIESEL	15-18
VOLKSWAGEN	JETTA	L4 2.0 DIESEL	09-14
VOLKSWAGEN	PASSAT	L4 2.0 DIESEL	12-15

OEM 1K0-199-262CB, 1K0-199-262-CR
1K0-199-262-CE

*Parque Vehicular: 157,1953

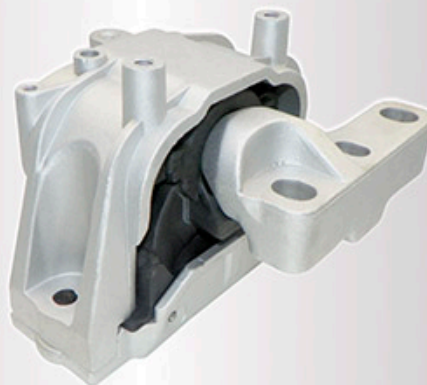

8385



7506024153959

SOPORTE PARA MOTOR TRASERO

MARCA	MODELO		
FIAT	500X	L4 1.4	16-18
JEEP	RENEGADE	L4 1.4	15-18
JEEP	RENEGADE	L4 1.8	17-20
JEEP	RENEGADE	L4 2.4	2015

OEM 68257232AA

*Parque Vehicular: 7,287



8398



7506024154833

BASE PARA AMORTIGUADOR FRONTAL IZQUIERDA Y DERECHA

MARCA	MODELO		
SUZUKI	KIZASHI	L4 2.4	10-13

OEM 4171057L00, 4174178K00

*Parque Vehicular: 2,892





8426-KIT





7506024155496

SOPORTE PARA TRANSMISIÓN AUTOMÁTICA

MARCA	MODELO		
CHEVROLET	CRUZE	L4 1.4	16-19

OEM 39037511

*Parque Vehicular: 83,373



8492



7506024155977

SOPORTE PARA TRANSMISIÓN STD.

MARCA	MODELO		
CHEVROLET	ONIX	L3 1.0	20-22
CHEVROLET	TRACKER	L3 1.0	20-22

OEM 26258698

*Parque Vehicular: 48,188





8514



7506024156028

SOPORTE PARA MOTOR DERECHO

MARCA	MODELO		
CHEVROLET	ONIX	L3 1.0	20-22
CHEVROLET	TRACKER	L3 1.0	20-22

OEM 26285535

*Parque Vehicular: 48,188



8519-H





7506024156240

BASE PARA AMORTIGUADOR FRONTAL DERECHA

MARCA	MODELO		
RAM	PROMASTER 1500	V6 3.0	14-21
RAM	PROMASTER 1500	V6 3.6	14-21
RAM	PROMASTER 2500	V6 3.0	14-19
RAM	PROMASTER 2500	V6 3.6	14-19
RAM	PROMASTER 3500	V6 3.0	14-21
RAM	PROMASTER 3500	V6 3.6	14-21

OEM 53199490

*Parque Vehicular: 6,542



8541-KIT



7506024156257

BASE PARA AMORTIGUADOR FRONTAL IZQUIERDA

MARCA	MODELO		
RAM	PROMASTER 1500	V6 3.0	14-21
RAM	PROMASTER 1500	V6 3.6	14-21
RAM	PROMASTER 2500	V6 3.0	14-19
RAM	PROMASTER 2500	V6 3.6	14-19
RAM	PROMASTER 3500	V6 3.0	14-21
RAM	PROMASTER 3500	V6 3.6	14-21

OEM 53199489

*Parque Vehicular: 6,542



8542-KIT





7506024159357

COMPLEMENTO PARA SOPORTE DE MOTOR TRASERO TRANSMISIÓN AUTOMÁTICA

MARCA	MODELO		
CHEVROLET	CAVALIER	L4 1.5	18-21

OEM 90905119

*Parque Vehicular: 248,593



8585



7506024159364

SOPORTE PARA TRANSMISIÓN

MARCA	MODELO		
BUICK	ENVISION	L4 2.0	16-20
BUICK	ENVISION	L4 2.5	17-20

OEM 13374290, 84160409

*Parque Vehicular: 1,984

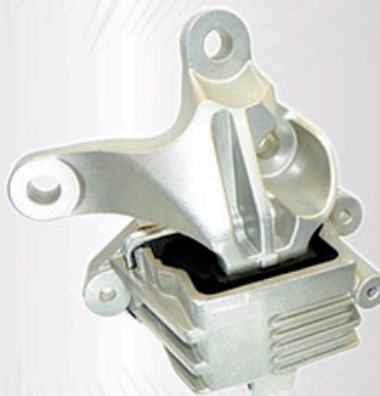

8586-H



7506024159371

SOPORTE PARA TRANSMISIÓN STD.

MARCA	MODELO		
HONDA	CIVIC	L4 1.5	17-21
HONDA	CIVIC	L4 2.0	2017

OEM 50850-TBC-A01

*Parque Vehicular: 299,823

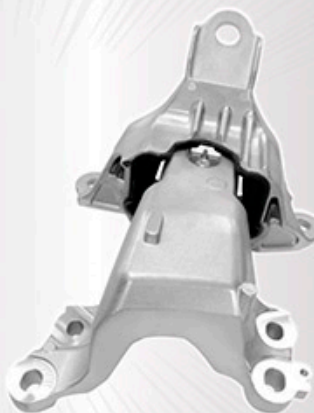

8587





7506024159401

SOPORTE PARA TRANSMISIÓN AUTOMÁTICA

MARCA	MODELO		
FORD	F-150	V6 3.5	17-21
FORD	LOBO	V6 3.5	17-20

OEM HL3Z6068C, HL3Z-6068-E
*Parque Vehicular: 587,753



8590



7506024159791

SOPORTE PARA TRANSMISIÓN STD.

MARCA	MODELO		
HONDA	ACCORD	L4 2.3	98-02

OEM 50805-S84-A01
*Parque Vehicular: 249,186



8591



7506024159425

SOPORTE PARA TRANSMISIÓN STD.

MARCA	MODELO		
CHEVROLET	CAVALIER	L4 1.5	18-21

OEM 26201831
*Parque Vehicular: 248,593

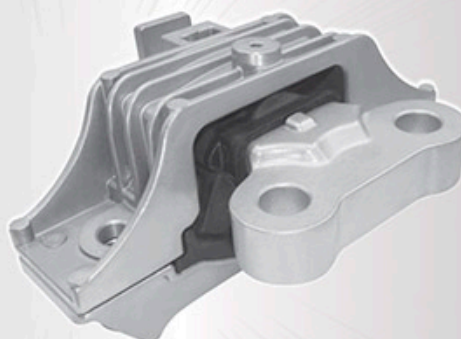

8592





7506024159432

SOPORTE PARA MOTOR TRASERO

MARCA	MODELO		
CHEVROLET	MALIBU	L4 1.5	16-22

OEM 23438164, 84501029

*Parque Vehicular: 129,840



8593



7506024159449

SOPORTE PARA TRANSMISIÓN

MARCA	MODELO		
HYUNDAI	SANTA FE	L4 2.4	09-12
HYUNDAI	SANTA FE	V6 3.5	09-12
KIA	SORENTO	L4 2.4	11-13
KIA	SORENTO	V6 3.5	11-13

OEM 21830 2P600, 21830 2P000

21830 2P500

*Parque Vehicular: 48,975



8594



7506024159470

SOPORTE PARA MOTOR TRASERO

MARCA	MODELO		
HONDA	HR-V	L4 1.8	16-21

OEM 50890-T7L-000

*Parque Vehicular: 81,418



8597



8598



7506024159487

SOPORTE PARA MOTOR TRASERO

MARCA	MODELO		
SUBARU	ASCENT	H4 2.4	19-22
SUBARU	B9 TRIBECA	H6 3.0	06-07
SUBARU	BAJA	H4 2.5	04-05
SUBARU	CROSSTREK	H4 2.0	16-21
SUBARU	CROSSTREK	H4 2.5	2021
SUBARU	FORESTER	H4 2.0	14-18
SUBARU	FORESTER	H4 2.5	09-21
SUBARU	IMPREZA	H4 2.0	02-05
SUBARU	IMPREZA	H4 2.0	12-16
SUBARU	IMPREZA	H4 2.0	19-21
SUBARU	IMPREZA	H4 2.2	99-01
SUBARU	IMPREZA	H4 2.5	99-14
SUBARU	LEGACY	H4 2.4	20-22
SUBARU	LEGACY	H4 2.5	20-22
SUBARU	LEGANCY	H4 2.5	00-09
SUBARU	LEGANCY	H6 3.0	08-09
SUBARU	OUTBACK	H4 2.4	20-22
SUBARU	OUTBACK	H4 2.5	02-09
SUBARU	OUTBACK	H4 2.5	20-22
SUBARU	OUTBACK	H6 3.0	05-09
SUBARU	TRIBECA	H6 3.0	08-14
SUBARU	WRX	H4 2.0	15-21
SUBARU	WRX STI	H4 2.5	15-20
SUBARU	XV CROSSTREK	H4 2.0	13-15



OEM 41040FE000, 41040AE02A
41040AC030, 41040AE02A9E
*Parque Vehicular: 136,075



7506024159494

SOPORTE PARA MOTOR TRASERO

MARCA	MODELO		
CHEVROLET	MALIBU	L4 2.0	16-22
BUICK	REGAL	L4 2.0	18-20

OEM 23356091

*Parque Vehicular: 136,321



8599



7506024159517

SOPORTE PARA MOTOR TRASERO

MARCA	MODELO		
HYUNDAI	SONATA	L4 1.6	16-19
HYUNDAI	SONATA	L4 2.0	15-17
HYUNDAI	SONATA	L4 2.4	15-19
KIA	OPTIMA	L4 2.0	2016
KIA	OPTIMA	L4 2.4	16-19

OEM 21950-C1100, 21950-C2050

*Parque Vehicular: 15,136



8601



7506024159524

SOPORTE PARA MOTOR TRASERO

MARCA	MODELO		
BUICK	ENVISION	L4 2.0	2016

OEM 13407198

*Parque Vehicular: 1,984



8602





7506024159531

SOPORTE PARA MOTOR TRASERO

MARCA	MODELO		
BUICK	ENVISION	L4 2.0	17-20
BUICK	ENVISION	L4 2.5	17-20

OEM 13374326, 84141172

*Parque Vehicular: 1,984



8603



7506024159555

SOPORTE PARA MOTOR FRONTAL

MARCA	MODELO		
BUICK	ENVISION	L4 2.0	16-20
BUICK	ENVISION	L4 2.5	17-20

OEM 23341146, 13374322

*Parque Vehicular: 1,984



8605



7506024159562

SOPORTE PARA TRANSMISIÓN

MARCA	MODELO		
JEEP	RENEGADE	L4 1.8	17-20

OEM 68368497AA, 68501155AA

*Parque Vehicular: 6,107



8606





7506024159579

**BASE PARA AMORTIGUADOR TRASERA
 IZQUIERDA Y DERECHA**

MARCA	MODELO		
BUICK	REGAL	L4 2.0	18-20
BUICK	REGAL	V6 3.6	18-20
CHEVROLET	MALIBU	L4 1.5	16-21
CHEVROLET	MALIBU	L4 1.8	16-19
CHEVROLET	MALIBU	L4 2.0	16-22

OEM 23393573

*Parque Vehicular: 136,321



8607



7506024159586

**BASE PARA AMORTIGUADOR TRASERA
 IZQUIERDA Y DERECHA**

MARCA	MODELO		
PEUGEOT	307	L4 2.0	03-11

OEM 5142.30

*Parque Vehicular: 20,603



8608



7506024159593

**BASE PARA AMORTIGUADOR TRASERA
 IZQUIERDA Y DERECHA**

MARCA	MODELO		
BUICK	CAVALIER	L4 1.5	18-20

OEM 26234166

*Parque Vehicular: 248,593



8609





7506024159609

BASE PARA AMORTIGUADOR TRASERA IZQUIERDA Y DERECHA

MARCA	MODELO		
PEUGEOT	3008	L4 2.0	18-20

OEM 9800559080

*Parque Vehicular: 5,080



8610



7506024159678

SOPORTE PARA MOTOR IZQUIERDO Y DERECHO

MARCA	MODELO		
MERCEDES BENZ	C230	L4 1.8	07-09
MERCEDES BENZ	C250	L4 1.8	08-11
MERCEDES BENZ	C350	V6 3.5	08-12
MERCEDES BENZ	GLK350	V6 3.5	09-12
MERCEDES BENZ	GLK350	V6 3.5	12-12
MERCEDES BENZ	S550	V8 5.5	07-09

OEM 204-240-20-17, 204-240-20-17-64

*Parque Vehicular: 8,406



8617-H



7506024159708

BASE PARA AMORTIGUADOR TRASERA IZQUIERDA Y DERECHA

MARCA	MODELO		
HONDA	CIVIC	L4 1.5	16-21
HONDA	CIVIC	L4 2.0	16-21

OEM 52670-TBG-A01

*Parque Vehicular: 299,823



8620



8616



7506024159661

SOPORTE PARA TRANSMISIÓN IZQUIERDO Y DERECHO

MARCA	MODELO		
BMW	118IA	L4 1.6	12-15
BMW	120IA	L4 1.6	2016
BMW	228I	L4 2.0	14-16
BMW	228I XDRIVE	L4 2.0	15-16
BMW	230I	L4 2.0	17-21
BMW	230I XDRIVE	L4 2.0	2017
BMW	320I	L4 2.0	13-18
BMW	320I XDRIVE	L4 2.0	13-18
BMW	328D	L4 2.0 DIESEL	14-18
BMW	328D XDRIVE	L4 2.0 DIESEL	14-18
BMW	328I	L4 2.0	12-16
BMW	328I GT XDRIVE	L4 2.0	2016
BMW	328I XDRIVE	L4 2.0	13-16
BMW	330E	L4 2.0	16-18
BMW	330I	L4 2.0	17-18
BMW	330I XDRIVE	L4 2.0	17-18
BMW	335I	L6 3.0	12-15
BMW	335I XDRIVE	L6 3.0	12-15
BMW	340	L6 3.0	16-18
BMW	340I XDRIVE	L6 3.0	16-18
BMW	428I	L4 2.0	14-16
BMW	428I GRAND COUPE	L4 2.0	15-16
BMW	428I XDRIVE	L4 2.0	14-16
BMW	430I	L4 2.0	17-20
BMW	430I GRAND COUPE	L4 2.0	17-20
BMW	430I XDRIVE	L4 2.0	17-20
BMW	435I	L6 3.0	14-16
BMW	435I GRAND COUPE	L6 3.0	15-16
BMW	435I XDRIVE	L6 3.0	14-16
BMW	440I	L6 3.0	17-20

MARCA	MODELO		
BMW	440I GRAND COUPE	L6 3.0	17-20
BMW	440I XDRIVE	L6 3.0	17-20
BMW	ACTIVE HYBRID 3	L6 3.0	13-15
BMW	M2	L6 3.0	2016
BMW	M235I	L6 3.0	14-16
BMW	M235I XDRIVE	L6 3.0	15-16
BMW	M240I	L6 3.0	17-20



OEM 22 31 6 796 617, 22 31 6 796 619
*Parque Vehicular: 55,693



7506024159722

BASE PARA AMORTIGUADOR TRASERA IZQUIERDA Y DERECHA

MARCA	MODELO		
HONDA	CR-V	L4 1.5	17-22
HONDA	CR-V	L4 2.0	20-22
HONDA	CR-V	L4 2.4	17-19

OEM 52670-TLA-A02

*Parque Vehicular: 339,406



8622



7506024159746

SOPORTE PARA TRANSMISIÓN

MARCA	MODELO		
TOYOTA	RAV-4	L4 2.0	98-00

OEM 12372-74610, 12372-74620

*Parque Vehicular: 172,981



8624



7506024159763

SOPORTE PARA TRANSMISIÓN

MARCA	MODELO		
BMW	X5	L6 3.0	07-18
BMW	X6	L6 3.0	08-19

OEM 22-31-6-864-675, 22-32-6-773-820

22-32-6-780-025

*Parque Vehicular: 21,681



8625





7506024159760

SOPORTE PARA MOTOR TRASERO

MARCA	MODELO		
TOYOTA	PRIUS	L4 1.8	10-17
LEXUS	CT200H	L4 1.8	11-17

OEM 12371-37090, 12371-37250

*Parque Vehicular: 28,262



8626



7506024159784

SOPORTE PARA MOTOR DERECHO

MARCA	MODELO		
CHEVROLET	AVEO	L4 1.5	18-22

OEM 26671545

*Parque Vehicular: 685,912



8628



7506024159814

SOPORTE PARA TRANSMISIÓN AUT. 6 VEL.

MARCA	MODELO		
CHEVROLET	CAVALIER	L4 1.5	18-21

OEM 90905203

*Parque Vehicular: 248,593

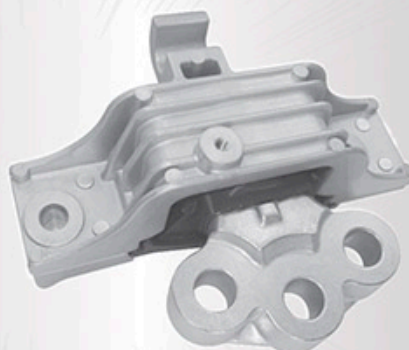



8631





7506024159821

SOPORTE PARA TRANSMISIÓN STD.
AUT. 5 VEL. GASOLINA

MARCA	MODELO		
FORD	RANGER	L4 2.5	13-20

OEM AB397E373GE

*Parque Vehicular: 321,229





8632



7506024159876

SOPORTE PARA DIFERENCIAL

MARCA	MODELO		
TOYOTA	HILUX	L4 2.7	05-15

OEM 52380-71030

*Parque Vehicular: 369,287





8637



7506024160216

SOPORTE PARA MOTOR TRASERO

MARCA	MODELO		
CHEVROLET	CAVALIER	L4 1.5	18-21

OEM 90905266

*Parque Vehicular: 248,593



8666





7506024160228

SOPORTE PARA MOTOR DERECHO SUPERIOR

MARCA	MODELO		
HONDA	ACCORD	L4 1.5	18-21
HONDA	ACCORD	L4 2.0	18-21

OEM 50880-TVA-A11, 50880-TVC-A31

*Parque Vehicular: 249,186



8667



7506024160230

SOPORTE PARA MOTOR DERECHO

MARCA	MODELO		
HONDA	CR-V	L4 1.5	17-22

OEM 50820-TLA-A01

*Parque Vehicular: 339,406



8668-H



7506024160247

SOPORTE PARA MOTOR DERECHO

MARCA	MODELO		
PEUGEOT	207	L4 1.6	2010
PEUGEOT	208	L4 1.6	12-16
PEUGEOT	2008	L4 1.6	14-16

OEM 1839.J2, 1839.F4

*Parque Vehicular: 26,934



8669





7506024160254

SOPORTE PARA TRANSMISIÓN

MARCA	MODELO		
PEUGEOT	207	L4 1.4	09-11
PEUGEOT	207	L4 1.6	08-14

OEM 1813.92

*Parque Vehicular: 17,134



8670



7506024160278

SOPORTE PARA MOTOR TRASERO

MARCA	MODELO		
NISSAN	MURANO	V6 3.5	09-14

OEM 11320-1AA1A

*Parque Vehicular: 13,423



8671-H



7506024160407

SOPORTE PARA TRANSMISIÓN

MARCA	MODELO		
TOYOTA	COROLLA	L4 1.8	14-19
TOYOTA	COROLLA	L4 2.0	2019

OEM 12372-21240, 12372-0T340
 12372-0T330

*Parque Vehicular: 312,555



8684





7506024160414

SOPORTE PARA MOTOR DERECHO SUPERIOR

MARCA	MODELO		
TOYOTA	HIGHLANDER	V6 3.5	10-15
LEXUS	RX-450	V6 3.5	11-16

OEM 12363-31070

*Parque Vehicular: 33,587



8685



7506024160438

SOPORTE PARA MOTOR DERECHO

MARCA	MODELO		
FORD	EXPLORER	V6 3.5	11-19
FORD	POLICE INTERCEPTOR	V6 3.7	13-19

OEM FB53-6F012-AB, GB5Z-6038-A

*Parque Vehicular: 136,338



8687-H



7506024160445

SOPORTE PARA TRANSMISIÓN

MARCA	MODELO		
FORD	EXPLORER	V6 3.5	11-19
FORD	POLICE INTERCEPTOR	V6 3.5	13-19
FORD	POLICE INTERCEPTOR	V6 3.7	13-19

OEM FB5Z-6038-B

*Parque Vehicular: 136,338



8688-H





7506024160452

SOPORTE PARA MOTOR TRASERO

MARCA	MODELO		
FORD	EXPLORER	L4 2.3	16-19

OEM FB5Z-6068-B

*Parque Vehicular: 136,338



8689



7506024160469

SOPORTE PARA TRANSMISIÓN (CON TURBO)

MARCA	MODELO		
FORD	EXPLORER	V6 3.5	11-19
FORD	FLEX	V6 3.5	10-19
FORD	POLICE INTERCEPTOR	V6 3.5	14-19
FORD	POLICE INTERCEPTOR	V6 3.7	13-19
FORD	TAURUS	V6 3.5	10-19
LINCOLN	MKS	V6 3.5	10-19
LINCOLN	MKT	V6 3.5	10-19
LINCOLN	MKT	V6 3.7	10-19

OEM DB5Z-6038-B, FB5Z-6038-B, AA5Z6038-B

*Parque Vehicular: 171,686

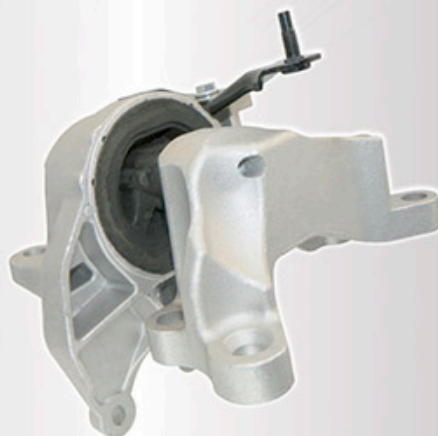

8690





7506024160476

SOPORTE PARA MOTOR DERECHO

MARCA	MODELO		
FORD	TRANSIT	L4 2.2	12-19

OEM GK21-6F012-BB

*Parque Vehicular: 19,295



8691



7506024160483

SOPORTE PARA MOTOR DERECHO

MARCA	MODELO		
FORD	ESCAPE	L4 1.5	17-19
FORD	ESCAPE	L4 1.6	13-16
FORD	TRANSIT CONNECT	L4 1.6	14-16

OEM CV61-6F012-CA, DV61-6F012-HA

*Parque Vehicular: 195,877



8692-H



7506024160490

SOPORTE PARA TRANSMISIÓN

MARCA	MODELO		
FORD	FIGO	L4 1.5	16-19

OEM E3B17M121AD, E3B17M121BC

*Parque Vehicular: 255,372



8693





7506024160513

SOPORTE PARA MOTOR DERECHO

MARCA	MODELO		
TOYOTA	YARIS	L4 1.5	16-18
MAZDA	2	L4 1.5	17-19
SCION	IA	L4 1.5	2016

OEM DB1M-39-060

*Parque Vehicular: 221,203



8695-H



7506024160520

SOPORTE PARA MOTOR DERECHO

MARCA	MODELO		
MAZDA	CX-7	L4 2.3	07-12
MAZDA	CX-7	L4 2.5	10-12

OEM EH48-39-06Y, -06YA
-060A, -060B, -060C

*Parque Vehicular: 37,453



8696-H



7506024160728

SOPORTE PARA MOTOR DERECHO

MARCA	MODELO		
RENAULT	FLUENCE	L4 2.0	11-16

OEM 11210-0039R

*Parque Vehicular: 22,362



8712





7506024160940

SOPORTE PARA MOTOR TRASERO

MARCA	MODELO		
PEUGEOT	3008	L4 2.0 DIESEL	20-22

OEM 1806 H0

*Parque Vehicular: 5,080



8714



7506024161497

SOPORTE PARA MOTOR TRASERO

MARCA	MODELO		
HYUNDAI	ACCENT	L4 1.6	03-05

OEM 21930-25400, 21930-25450

*Parque Vehicular: 50,210



8716



7506024162258

SOPORTE PARA TRANSMISIÓN

MARCA	MODELO		
MERCEDES BENZ	SPRINTER 2500	V6 3.0	03-08
MERCEDES BENZ	SPRINTER 3500	V6 3.0	03-08

OEM 901 242 14 13, 901 242 15 13

*Parque Vehicular: 13,543



8749





7506024162265

SOPORTE PARA TRANSMISIÓN STD.

MARCA	MODELO		
FIAT	PUNTO	L4 1.4	05-13
ALFA ROMEO	MITO	L4 1.4	08-18

OEM 55700434

*Parque Vehicular: 847



8750



7506024162319

SOPORTE PARA MOTOR DERECHO

MARCA	MODELO		
PEUGEOT	PARTNER	L4 1.6	08-20

OEM 1807GF, 1807X2

*Parque Vehicular: 40,210



8751-H



7506024150187

CUBRE POLVO IZQUIERDO Y DERECHO LADO CAJA AUT.

MARCA	MODELO		
FORD	ECO SPORT	L4 2.0	07-12

OEM N/D

*Parque Vehicular: 162,460



63209





7506024150415

63232

**CUBRE POLVO IZQUIERDO Y DERECHO
 LADO CAJA STD. Y AUT.**



MARCA	MODELO		
CHRYSLER	PT CRUISER	L4 2.4	01-10
DODGE	NEON	L4 2.4	00-05

OEM N/D
 *Parque Vehicular: 220,296



7506024150446

63235

**CUBRE POLVO IZQUIERDO Y DERECHO
 LADO CAJA STD.**



MARCA	MODELO		
CHEVROLET	AVEO	L4 1.5	19-22

OEM N/D
 *Parque Vehicular: 685,912



7506024158411

63262

**CUBRE POLVO IZQUIERDO
 LADO CAJA STD. (TURBO)**



MARCA	MODELO		
DODGE	CALIBER	L4 2.4	08-09

OEM N/D
 *Parque Vehicular: 23,897



7506024161206

CUBRE POLVO IZQUIERDO Y DERECHO LADO CAJA AUT.

MARCA	MODELO		
HYUNDAI	GRAND I10	L4 1.2	15-22

OEM 49542-B4100

*Parque Vehicular: 685,912



63285



7506024159067

JUEGO DE GOMAS PARA BARRA ESTABILIZADORA FRONTAL 21.5 mm

MARCA	MODELO		
NISSAN	MICRA	L4 1.4	02-10

OEM 77 01 062 549

*Parque Vehicular: 5,645

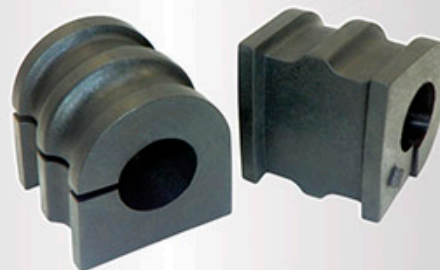

64871



7506024159074

JUEGO DE GOMAS PARA BARRA ESTABILIZADORA TRASERA 19 mm

MARCA	MODELO		
NISSAN	X-TRAIL	L4 2.5	14-19
NISSAN	ROGUE	L4 2.5	15-19

OEM 54613-JG17C

*Parque Vehicular: 293,228

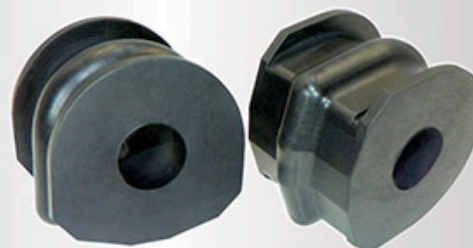

64872





7506024159128

JUEGO DE GOMAS PARA BARRA ESTABILIZADORA FRONTAL

MARCA	MODELO		
FORD	MONDEO	L4 2.0	00-07
FORD	MONDEO	V6 2.5	00-07
FORD	MONDEO	V6 3.0	00-07

OEM 93BB-5484-AB, YS81-5484-AA

*Parque Vehicular: 33,147

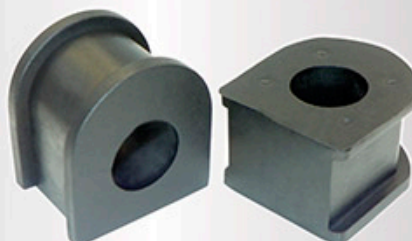

DAI-1406102



7506024147996

JUEGO DE GOMAS PARA BARRA ESTABILIZADORA FRONTAL

MARCA	MODELO		
NISSAN	X-TRAIL	L4 2.5	02-07

OEM N/D

*Parque Vehicular: 262,961



DAI-1416065



7506024161107

TORNILLO ESTABILIZADOR TRASERO 200 mm

MARCA	MODELO		
FORD	RANGER	L4 2.3	93-97
FORD	RANGER	L4 2.3	01-11
FORD	RANGER	L4 2.5	98-01
FORD	RANGER	V6 3.0	98-03
FORD	RANGER	V6 4.0	93-11

OEM F77Z-5K484-GA

*Parque Vehicular: 321,229



DAI-2108046



7506024161329

TIRANTE SUPERIOR TRASERO

MARCA	MODELO		
CHRYSLER	CIRRUS	L4 2.0	01-06
CHRYSLER	CIRRUS	V6 2.7	01-06
CHRYSLER	CIRRUS	V6 3.0	01-02
CHRYSLER	SEBRING	L4 2.4	01-06
CHRYSLER	SEBRING	V6 2.7	01-06
CHRYSLER	SEBRING	V6 3.0	01-06
DODGE	STRATUS	L4 2.0	01-06
DODGE	STRATUS	V6 2.7	01-06
DODGE	STRATUS	V6 3.0	01-06

OEM 5135565AB, 04895264AA

*Parque Vehicular: 346,249



DAI-1506120



7506024161114

TORNILLO ESTABILIZADOR TRASERO

276 mm

MARCA	MODELO		
FORD	RANGER	L4 2.3	93-97
FORD	RANGER	L4 2.3	01-11
FORD	RANGER	L4 2.5	98-01
FORD	RANGER	V6 3.0	98-03
FORD	RANGER	V6 4.0	93-11

OEM F77Z-5K484-HA

*Parque Vehicular: 321,229





DAI-2108057



7506024161121

TORNILLO ESTABILIZADOR FRONTAL DERECHO

MARCA	MODELO		
FORD	RANGER	L4 2.2	13-20

OEM N/D

*Parque Vehicular: 321,229





DAI-2108064



7506024161138

TORNILLO ESTABILIZADOR FRONTAL IZQUIERDO

MARCA	MODELO		
FORD	RANGER	L4 2.2	13-20

OEM N/D

*Parque Vehicular: 321,229





DAI-2108065



7506024161060

TORNILLO ESTABILIZADOR TRASERO DERECHO

MARCA	MODELO		
HONDA	CIVIC	L4 1.3	03-05
HONDA	CIVIC	L4 1.7	01-05
HONDA	CIVIC	L4 2.0	03-05

OEM 52320-S5A-013

*Parque Vehicular: 299,823





DAI-2109008





7506024161077

TORNILLO ESTABILIZADOR TRASERO IZQUIERDO

MARCA	MODELO		
HONDA	CIVIC	L4 1.3	03-05
HONDA	CIVIC	L4 1.7	01-05
HONDA	CIVIC	L4 2.0	03-05

OEM 52321-S5A-013

*Parque Vehicular: 299,823



DAI-2109009



7506024161084

TORNILLO ESTABILIZADOR TRASERO IZQUIERDO

MARCA	MODELO		
HONDA	CIVIC	L4 1.5	12-15
HONDA	CIVIC	L4 1.8	12-15
HONDA	CIVIC	L4 2.0	12-15

OEM 51321-TR0-A01

*Parque Vehicular: 299,823



DAI-2109049



7506024161091

TORNILLO ESTABILIZADOR FRONTAL DERECHO

MARCA	MODELO		
HONDA	CIVIC	L4 1.5	12-15
HONDA	CIVIC	L4 1.8	12-15
HONDA	CIVIC	L4 2.0	12-15

OEM 51320-TR0-A01

*Parque Vehicular: 299,823



DAI-2109050





7506024161152

**TORNILLO ESTABILIZADOR
 TRASERO IZQUIERDO Y DERECHO**

MARCA	MODELO		
NISSAN	X-TRAIL	L4 2.5	02-07

OEM 56261-EQ000
 *Parque Vehicular: 262,961



DAI-2116027



7506024161305

**JUEGO DE GOMAS PARA BARRA
 ESTABILIZADORA TRASERA**

MARCA	MODELO		
HONDA	CR-V	L4 2.4	02-06

OEM 52306-S9A-005
 *Parque Vehicular: 339,406



DAI-5039028



7506024162203

**TORNILLO ESTABILIZADOR
 TRASERO IZQUIERDO Y DERECHO**

MARCA	MODELO		
AUDI	Q7	V6 3.0	06-15
AUDI	Q7	V6 3.2	07-10
AUDI	Q7	V8 3.6	07-10
AUDI	Q7	V8 4.2	07-10
PORSCHE	CAYENNE	V6 3.0	11-18
PORSCHE	CAYENNE	V6 3.2	04-06
PORSCHE	CAYENNE	V6 3.6	08-18
PORSCHE	CAYENNE	V8 4.5	03-06
PORSCHE	CAYENNE	V8 4.8	08-18
VOLKSWAGEN	TOUAREG	V6 4.2	04-18
VOLKSWAGEN	TOUAREG	V10 5.0	04-09



OEM 710-411-317
 955-343-069-10, 955-343-069-00
 *Parque Vehicular: 353,813

DAI-955343069



DAI-K-3173



7506024161053

TORNILLO ESTABILIZADOR FRONTAL IZQUIERDO Y DERECHO

MARCA	MODELO		
JEEP	CHEROKEE	L4 2.1	85-87
JEEP	CHEROKEE	L4 2.5	84-93
JEEP	CHEROKEE	V6 2.8	84-86
JEEP	CHEROKEE	L6 4.0	87-93
JEEP	CJ7	L4 2.5	84-86
JEEP	CJ7	L6 4.2	84-86
JEEP	COMANCHE	L4 2.1	86-87
JEEP	COMANCHE	L4 2.5	86-92
JEEP	COMANCHE	V6 2.8	1986
JEEP	COMANCHE	L6 4.0	87-92
JEEP	GRAND WAGONEER	L6 4.2	84-86
JEEP	GRAND WAGONEER	V8 5.9	84-91
JEEP	J10	L6 4.2	84-87
JEEP	J10	V8 5.9	84-88
JEEP	J20	V8 5.9	84-88
JEEP	SCRAMBLER	L4 2.5	84-85
JEEP	SCRAMBLER	L6 4.2	84-85
JEEP	WAGONNER	L4 2.1	1985
JEEP	WAGONEER	V6 2.5	84-87
JEEP	WAGONEER	V6 2.8	84-86
JEEP	WAGONEER	L4 4.0	87-90

OEM 52003360

*Parque Vehicular: 125,407



MEDIDAS

2 GOMAS DEL MISMO TAMAÑO

64871

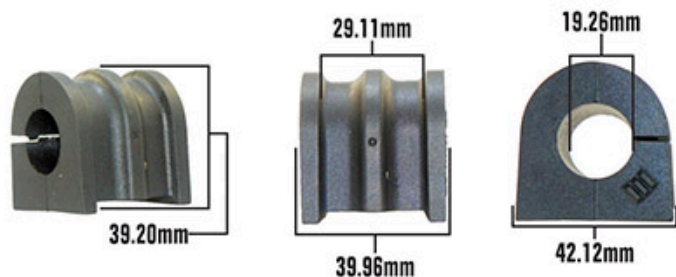

2 GOMAS DEL MISMO TAMAÑO

64872

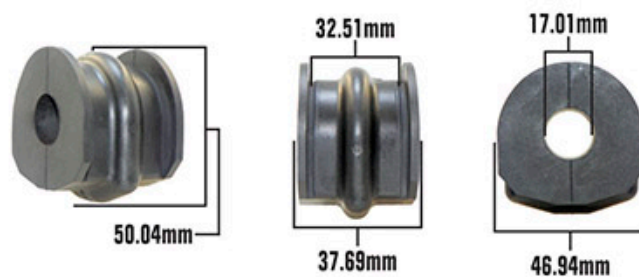

2 GOMAS DEL MISMO TAMAÑO

DAI-1406102

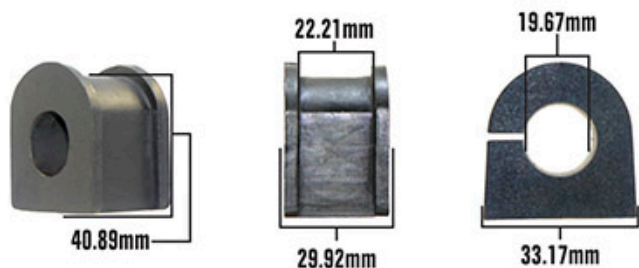

2 GOMAS DEL MISMO TAMAÑO

DAI-1416065

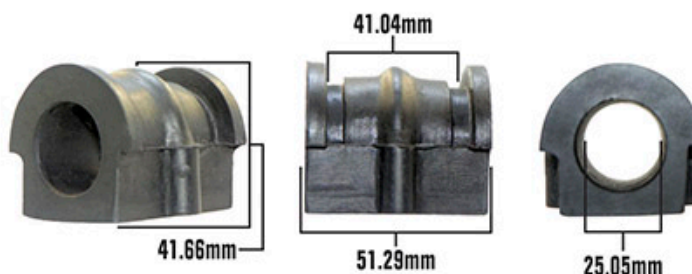

2 GOMAS DEL MISMO TAMAÑO

DAI-5039028

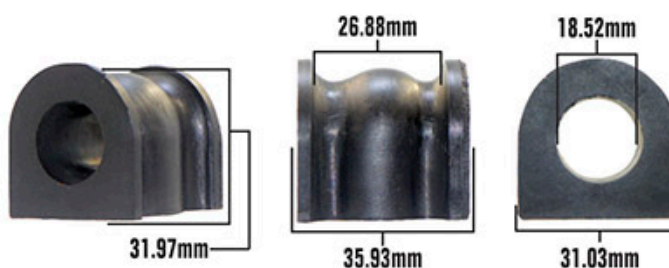

En espera de su apoyo para el buen desplazamiento de este producto quedo de ustedes.
Atentamente

Dirección Comercial